

Screw-cap Tester DTXS/DTXA series

Feature 1: High repeatability by high speed sampling rate.

Feature 2: Various sample torque can be measured with the multiple tables and attachments

Feature 3: Useful functions improving work efficiency.



↑DTXA-10N



↑Opening PET bottle cap torque test

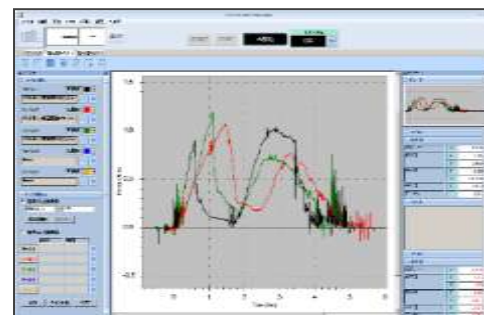

↑Graphing software Force Recorder Standard
(Selling separated item)

Feature 1: High repeatability by high speed sampling.

The high speed data sampling rate (2000 data / sec) captures momentary force and digitizes it. It helps to capture accurate force and realizes high repeatability at repeating the same measurements.

Feature 2: Various sample torque can be measured with the multiple tables and attachments

Changeable pins, tables and attachments. The users can choose the most suitable combination for their sample.



Change the table



Insert other attachment or table

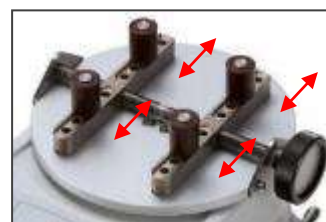

The pin types and the positions are changeable.

Feature 3: Useful functions improving work efficiency.



Organic Electroluminescence Display

The display is visually clear as the user can see it from the side or in a dark place.



Various display

○ Time display
Easy but certain data managements

○ Bar graph

Prevention of breaking the sensor(over load)(*1).

High performance various displays!!

Import the capture data to PC by included software



Display Force value/Date and time/OK/NG judgment by connecting PC with a USB connection.

Stable body fixation



The body can be fixed on a desk with the carry handle holes. It supports testing stable.

*1 This function is NOT preventing system from overloading. It could cause overload when huge force at short time is applied on the sensor part.

[DTXA limited functions]

Data saving to USB flash drive

Connect a USB flash drive with the included cable and save continuous data (100 data/min).

⇒ The measurements without PC can be drawn graphs on Microsoft Excel.



Saving Start/ Stop by pressing the send button.

Displaying multiple peaks

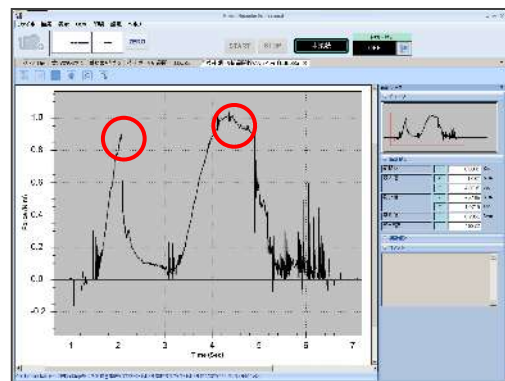

On the DTXA monitor, measuring 2 peak values and Max. value can be displayed at the same time.

⇒ For example, when measuring PET bottle cap torque.

▶ 1. Opening start force

▶ 2. Opening finish force

Two peak values are possible to see on the same monitor.

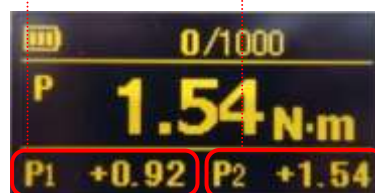

[DTX series force range]

➤Standard table / Standard pins are included

Model		Range	Display	Resolution
DTXA-2N	DTXS-2N	2 N-m (200N-cm)	2.000N-m (200.0N-cm)	0.001N-m (0.1N-cm)
DTXA-5N	DTXS-5N	5 N-m (500N-cm)	5.000N-m (500.0N-cm)	0.001N-m (0.1N-cm)
DTXA-10N	DTXS-10N	10N-m (1000N-cm)	10.00N-m (1000N-cm)	0.01N-m (1N-cm)

[DTXS/DTXA series specification]

2 models are available for your needs.

Model	DTXA	DTXS
Outline	Advanced model equipping various functions such as input/output the angles and saving to USB flash drive.	Simple standard model maintaining DTXA performance.
Accuracy	±0.5%F.S.±1 digit	
Unit of measurement	N-m, N-cm, kgf-m, kgf-cm, lbf-in, ozf-in (Unit switching is possible.)(*1)	
Display	4-digit	
Display update	10 times /sec	
Sampling rate	Maximum 2000 data/ sec(*2)	
Battery	8 hours (8 hours full charge)(*3)	
Safe overload rating	Approx. 200%	
Operating Environment	Temperature: 0 – 40 degree Celsius Humidity: 20 -80%RH	
Function	Customized display(header and footer) / Peak hold(Clockwise and Counterclockwise)/ Internal memory(1000 point data) / Comparator (OK or NG judgment)/ Reversible display/ Sign inversion/ Zero clear timer/ +NG alarm/ Off timer(Auto power off)/ Dumping/ Time display	
	1st2nd peak/ Angle detection at torque peak value(*4) / Angle zero reset at selected torque(*4)	-
Output	USB, RS232C, Mitutoyo digimatic (*5), 2 VDC analog output (D/A), Comparator 3 steps (-NG/OK/+NG), Overload alarm	
	Sub comparator 2 steps (output of large or small judgment), USB flash drive, Angle(displacement)	-
Overload warning	Approx.110%F.S. (Warning message and alarm)	
External connecting switch	SEND (a point of contact holding), Zero reset, Peak ON/OFF setting	
Weight	Approx. 4.5kg	
Dimensions	Please refer to dimensions.	
Accessory	AC adapter, Inspection certificate, CD driver (including simple software for data logging), , USB cable, Carrying case, L wrench, handles (10N-m range only)	
	USB flash drive adapter (*6)	-

*1 These are the specifications for International model. Please note that this unit is different from Japanese domestic model and international one.

*2 The recording rate to USB flash drive is maximum 100Hz.



*3 The battery is more consumed when connected to USB flash drive or a displacement scale.

*4 Angle(displacement) scale is necessary to valid this function.

*5 Not always available for Mitutoyo digimatic products.

*6 USB flash drive is not included



[Accessories]

Data logger Simple software ZT-Logger	Main Functions - Captures peak data - Captures continuous data (10 data /sec) - The recall of memory data - Saves data in CSV format * Available data: Torque, Angle, Time	
	Working Environment - OS: Windows XP/Vista/7/8(32bit/64bit) - CPU: more than 1GHz - Memory: more than 1GB - Hard disk : more than 2GB - .NET Framework4 later * Please note that the software may not work in all environmental combinations.	
Graphing software Trial version Force Recorder Professional Trial Edition Trial limit is 30days after installation.	Main Functions - Making a graph with 2000Hz sampling speed - Function to input memo to record information * Some functions are limited with trial edition. Please refer specification of Force Recorder for the detail of functions.	
	Working Environment - OS: Windows XP/Vista/7/8(32bit/64bit) - CPU: more than 1GHz - Memory: more than 1GB - Hard disk : more than 2GB - .NET Framework4 later * Please note that the software may not work in all environmental combinations.	

[Table Variations]

DTX series can be changed the table depending on the varieties of samples.

◆Standard Table



Standard table	Standard pin	Feature
		The table is available for $\phi 20\text{mm} \sim \phi 160\text{mm}$ samples such as PET bottles, cans, bins and so on. Capacity is 10N-m. (The pin material: Stainless-steel and Urethane)
		The combination model of DTXS/DTXA series, Standard Table and Standard pins
		DTXS series : DTXS- $\circ\circ$ N DTXA series: DTXA- $\circ\circ$ N *Please, choose $\circ\circ$ N from 2N, 5N or 10N.

The pins are able to change below types.

Please refer to option attachment specifications for the details.

	Notch pin	Long clamp pin
Material	Stainless-steel	Stainless-steel and Urethane
Option pin		

◆Small table

Small table	Standard pin	Feature
		Ideal table attachment for small samples $\phi 7\text{mm} \sim \phi 50\text{mm}$. (The pin material: Stainless-steel and Urethane) *It is not able to mount to 10N-m type.
		The combination model of DTXS/DTXA and Small table and Standard pins
		DTXS series:DTXS- $\circ\circ$ N-ST DTXA series:DTXA- $\circ\circ$ N-ST *Please, choose $\circ\circ$ N from 2N or 5N.



The pins are able to change below types.
Please refer to option attachment specifications for the details.

	Notch pin	Long clamp pin
Material	Stainless-steel	Stainless-steel and Urethane
Option pin		

◆No table model (Model: DTXS- $\circ\circ$ N-Z or DTXA- $\circ\circ$ N-Z)





DTXS/DTXA solely selling is available. It can be mounted below the pin chuck and the original jigs the user creates.

Pin chuck DT-DC series

	Feature
	The three claws clamp samples such as wire and round-bar samples. Choose the size from Large/Medium/Small size.

[Table Accessary]

◆Sample stage for Standard table

	Using Image	Model
		TB-SP
		Feature
The stage making samples stable.		

[Related products]

Graphing Software: Force Recorder

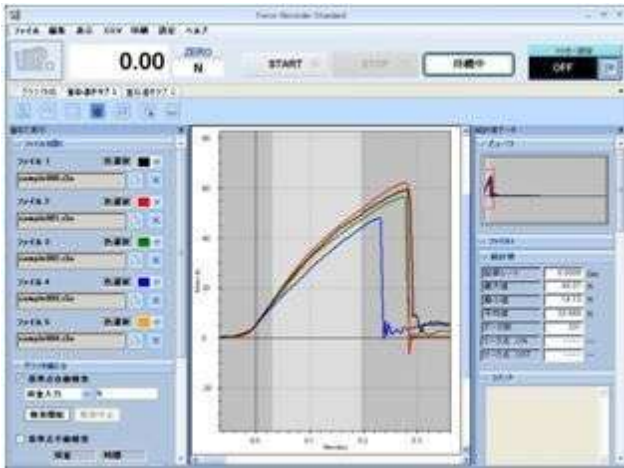



Main functions

- You can make graphs of force-displacement at real time via USB connection at 2000Hz.
- 5 graphs at maximum can be overlaid. (Standard, Professional edition)
- You can write memo on each graph. You may write down testing conditions such as testing speed.

* 3 editions are available as Light, Standard, and Professional.

* Please refer to each specification for further information.

*The image is Force Recorders Standard.

Printer : DP-1VR	Option cable	Replacement battery : BP-308
	Analog(3m) : CB-108	
	RS232C Cable (3m) : CB-208	
	Digimatic cable(3m) : CB-308	
	Contact point cable (3m) : CB-808	
	Open end cable (3m) : CB-908	
Prints indicated values and data in internal memory. *CB-308 cable is necessary.	Various cables are available.	Battery for replacement.

[Dimensions]

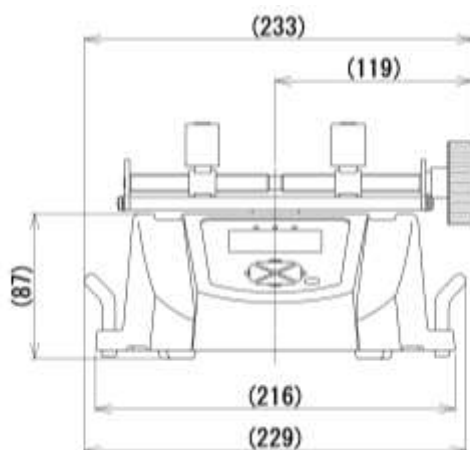
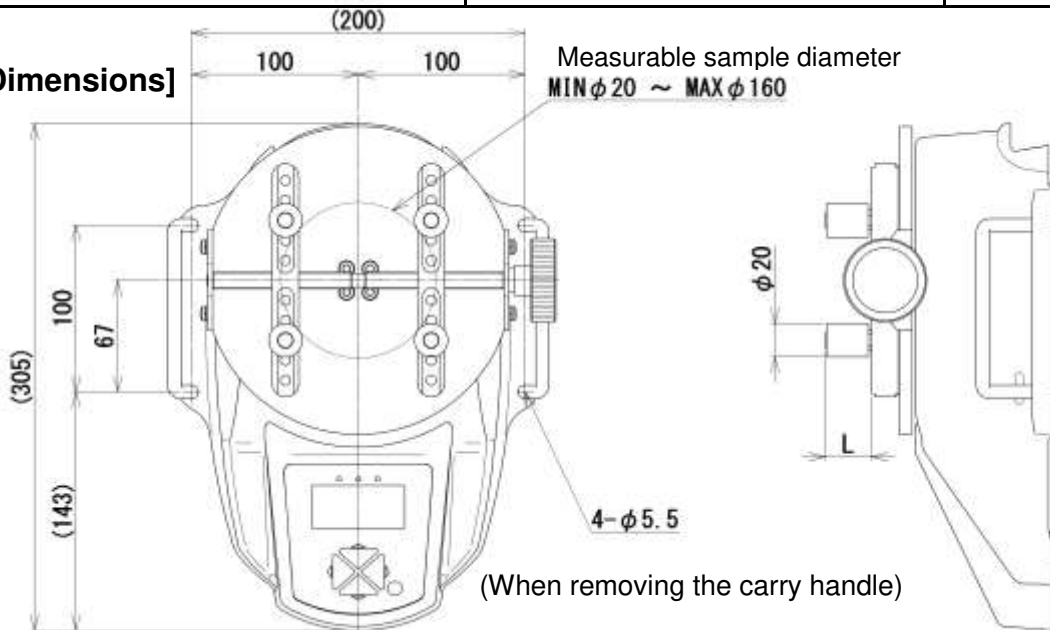

[Calibration Certificate]

- We offer calibration certificate with extra charge.
- * Please contact us or our distributor in your country for further information.

[Cautions]

- The contents may be changed without previous notice.
- All of products are designed for measurement purpose only.
- Do not copy and use this content without authority.
- Please note if you add load over capacity, its sensor would be broken down.
- Please note some samples are not able to be clamp by the materials or the clamp pin types.